

0.050 FC

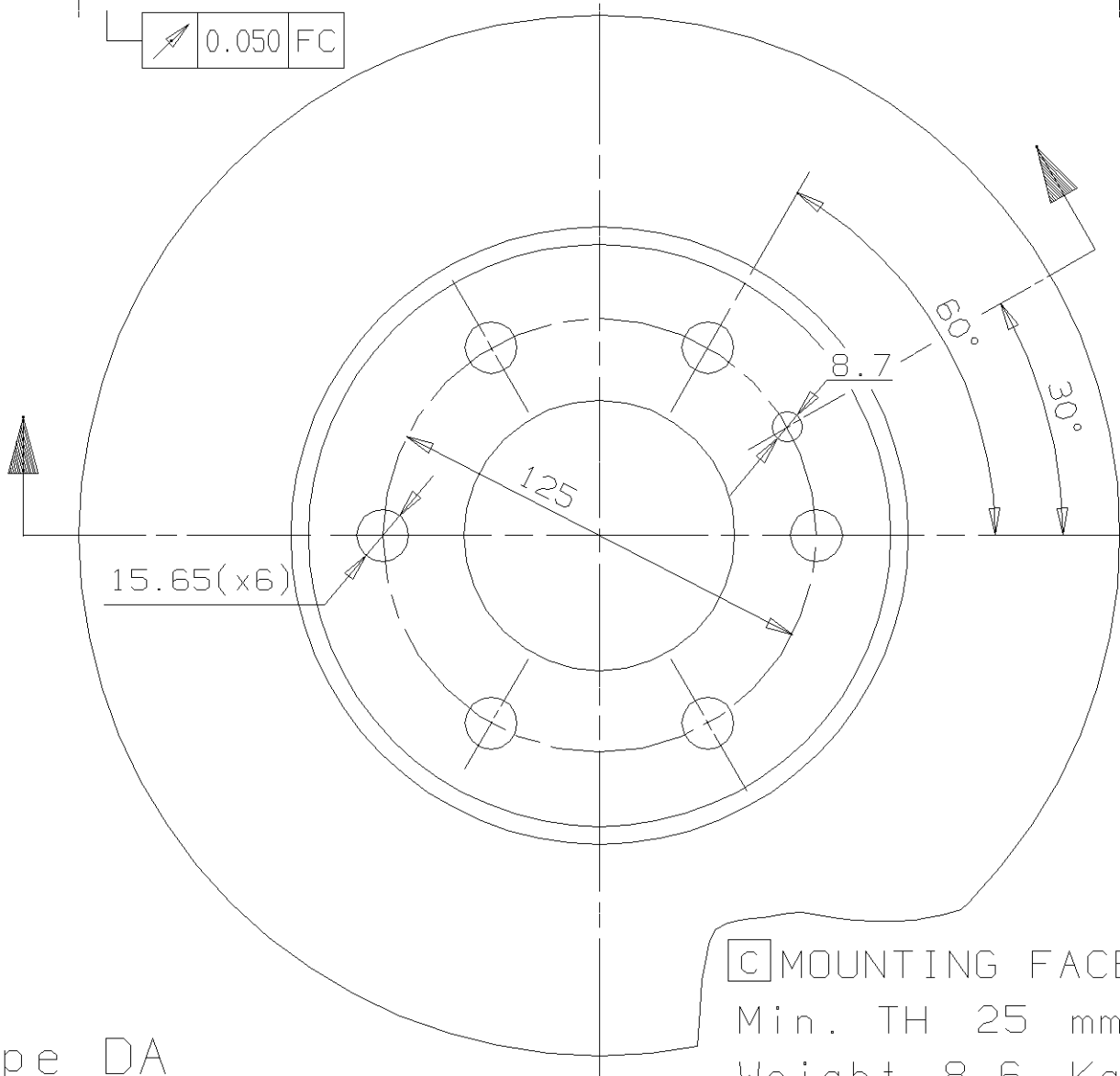

C MOUNTING FACE
 Min. TH 25 mm
 Weight 8.6 Kg

Type DA